

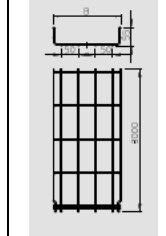

Passerelle a filo



Passerella grigliata GR-Magic

	Prog.	Codice	Descrizione	Misura	Sezione utilizzabile
	72639	6001442	GRM55/100	100x55	40
	72640	6001444	GRM55/150	150x55	63
	72238	6001446	GRM55/200	200x55	87
	72641	6001448	GRM55/300	300x55	129

Morsetto per passerella grigliata in versione avvitata

	Prog.	Codice	Descrizione
	72642	6016596	GSV 34 G

Morsetto per il fissaggio a pavimento

	Prog.	Codice	Descrizione	Foro
	74075	6015263	GKS 50	11mm

Mensola TP per passerella e profilato

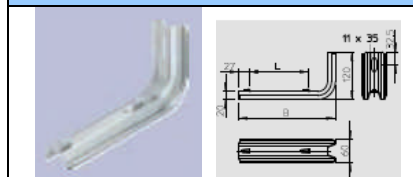
	Prog.	Codice	Descrizione	Misura mm
	72643	6366015	TPSAG/145	145X100
	72644	6366023	TPSAG/195	195X150
	72645	6366031	TPSAG/245	245X200
	72646	6366066	TPSAG/345	345X300

Staffa distanziatrice per passerella grigliata

	Prog.	Codice	Descrizione	Misura mm
	72647	6015654	DBLG20/10	100
	72648	6015658	DBLG20/15	150
	72649	6015662	DBLG20/20	200
	72650	6015670	DBLG20/30	300

Piastra di montaggio per il fissaggio senza viti

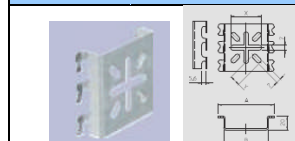
	Prog.	Codice	Descrizione	Misura
	72651	6006487	MPG/90FT	111x95x45x38

Sistemi di fissaggio per putrelle

Graffa di supporto per montaggio

	Prog.	Codice	Tipo	Spessore flangia	Dim. Foro
	72658	1481010	TK 6-0	2/6	6.5
	71164	1481029	TK 13-0	5/13	7
	71165	1481045	TK 19-0	14/19	7

Graffa con bandiera per montaggio

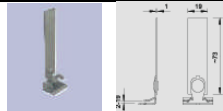
	Prog.	Codice	Tipo	Spessore flangia
	72659	1481207	TKB 6	2/6
	72660	1481215	TKB 13	5/13
	72661	1481231	TKB 19	14/19

Graffa con fascetta per cavi

	Prog.	Codice	Tipo	Spessore flangia	Dim. Foro	Lunghezza fascetta riapribile
	72662	1481401	TKK 6-240	2/6	70	240
	72663	1481452	TKK13-240	5/13		
	72664	1481533	TKK19-240	14/19		

Graffa con clip orizzontale

	Prog.	Codice	Tipo	Spessore flangia	Diam.
	72665	1483013	TKS 6-25	2/6	18/25
	72675	1483021	TKS 6-32	2/6	28/32
	72666	1483102	TKS 13-25	2/6	35/37
	72676	1483110	TKS 13-32	5/13	28/32
	72667	1483307	TKS 19-25	14/19	18/25
	72677	1483315	TKS 19-32	14/19	28/32

Graffa con clip verticale

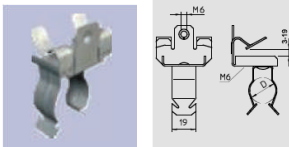
	Prog.	Codice	Tipo	Spessore flangia	Diam.
	72668	1484303	TKSU 7-25	3/6,5	18/25
	72678	1484311	TKSU 7-32	3/6,5	28/32
	72669	1484400	TKSU13-25	7/13	18/25
	72679	1484419	TKSU13-32	7/13	28/32
	72670	1484508	TKSU19-25	14/19	18/25
	72680	1484516	TKSU19-32	14/19	28/32

Profilato asolato a U da mt.2

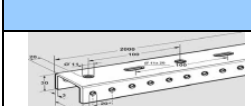
	Prog.	Codice	Tipologia
	72711	6485941	Pesante
	72712	6485942	Medio

Profilato asolato a C da 3 mt zincato

	Prog.	Codice	Misura
	72714	1122433	41X21
	72713	1122897	41X41

Nastro asolato

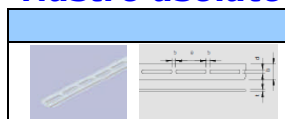
	Prog.	Codice	Articolo	Collare M.
	72703	1465775	5050	25X3 - 60

Asta filettata mt.1

	Prog.	Codice	Tipo	Filettatura
	72681	3141047	2078	M 6
	72682	3141128	2078	M 8
	72683	3141209	2078	M10

Manicotto distanziatore Art.965

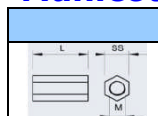
	Prog.	Codice	Filettatura
	72684	3415066	M 6x25
	72685	3415163	M 8x30

Giunto a manicotto Art.12005

	Prog.	Codice	Filettatura
	72686	6410081	M8
	72687	6410103	M10

Vite a testa esagonale

	Prog.	Codice	Articolo	Misura
	72695	3158209	342	8X20
	72696	3160203		10X20

Dado esagonale DIN 934

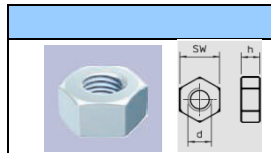
	Prog.	Codice	Filettatura
	72689	3400069	M 6
	72690	3400085	M 8
	72691	3400107	M10



Dado flangiato con rondella

	Prog.	Codice	Descrizione
	72688	6408958	KM M6 G

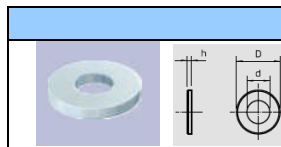
Rondella 966

	Prog.	Codice	Filettatura
	72692	3402444	M 6
	72693	3402452	M 8
	72694	3402460	M10



Graffa di supporto per avvitemento

	Prog.	Codice	Tipo	Spessore flangia
	72671	1484702	TK 213	2/13
	72673	1488023	FL 2	0/19
	71958	1488074	FL1-GM 8	0/17
	72674	1488082	FL2-GM10	0/19

Catena

	Prog.	Codice	Tipo		Imballo
	72234	1488201	K-C30	Catena di sospensione	25mt
	72236	1488252	SH 40	GANCIO A S	

Morsetti fissacavo scorrevoli

		Prog.	Codice	Tipo	Capacità
	Profilato	69930	1106120	2060S	2000x20x80
	Morsetti	28447	2254026	2050	5-25
		74208	2254034	2051	8-36

Mensola a parete e profilato MWA 12 foro 11

	Prog.	Codice	Descrizione	Misura mm
	72698	6424716	MWA 12/11	110x53x32.5
	72699	6424732	MWA 12/21	210x.65x32.5
	72700	6424740	MWA 12/31	310x75x38
	72701	6424759	MWA 12/41	410x83x38

Supporto a soffitto per il montaggio nel verso contrario del profilato US5

	Prog.	Codice	Descrizione
	72702	6348939	KUS5NOK

Mensola parete e profilato

	Prog.	Codice	Descrizione
	72735	6420909	AW 15/11
	72737	6420912	AW 15/16
	72739	6420915	AW 15/21
	72740	6420918	AW 15/31
	72742	6420921	AW 15/41
	72743	6420924	AW 15/51
	72744	6420927	AW 15/61



Morsetto per fissaggio

	Prog.	Codice	Descrizione
	72735	1124635	GTKS

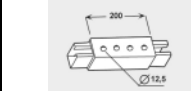

Piastra Di Prolunga Esterna A "U", 4 Fori, Per Profilato Strutturato

	Prog.	Codice	Descrizione
	72718	1124641	GVMS



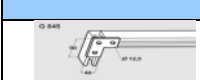

Piastra lineare per profilato

	Prog.	Codice	Fori	Descrizione
	72719	1124645	2	GMS2
	72720	1124649	4	GMS4
	72721	1124651	5	GMS5

Piastra per profilato GMS

	Prog.	Codice	Tipo	Fori
	72722	1124653	L	3
	72723	1124655	T	3
	72724	1124657	CROCE	5



Squadretta 90° Per Profilato Strutturato GMS

	Prog.	Codice	Fori
	72725	1124659	2
	72726	1124661	3
	72727	1124663	4
	72728	1124665	4 Rinforzata

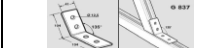
Squadretta 45°, 3 Fori, Per Profilato GMS

	Prog.	Codice	Fori
	72730	1124667	3
	72731	1124669	4

Omega per profilato GMS

	Prog.	Codice	Barra	Articolo	Misura
	72732	1124671	8821	4121	P=21 ZF
	72733	1124673	8841	4141	P=41 ZF

Gancio ad ancora con dado

	Prog.	Codice	Articolo	Misura
	72717	1148906	HKFG22	M10X30

Blocco potenziale e di connessione di messa a terra

	Prog.	Codice	Descrizione	Lunghezza
	58151	5016118	1805/4 VA	302
	57439	5016126	1805/6 VA	404

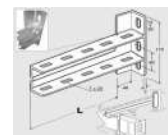

Mensola Gz - Con Doppia Possibilita' D' Aggancio

	Prog.	Codice	Articolo	Misura
	72745	6485981	GAH 11	L=110
	72746	6485982	GAH 16	L=160
	72747	6485983	GAH 21	L=210
	72748	6485984	GAH 26	L=260
	72749	6485985	GAH 31	L=310
	72750	6485986	GAH 41	L=410
	72751	6485987	GAH 51	L=510
	72752	6485988	GAH 61	L=610
	72753	6485989	GAH 71	L=710

Flangia a soffitto o pavimento singola pesante (conf.2pz)

	Prog.	Codice	
	72755	6485995	GDP FLANGIA SOFFITTO/ PAVIMENTO SINGOLA RINFORZATA
	72754	6485945	GKV FLANGIA REGOLABILE

Messa a terra

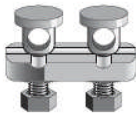
	Prog.	Codice	Articolo	Vie	
	73698	5000980	214/C		Puntazze a croce mt.1.5
	69610	5304105	5001	1	Morsetto di derivazione singolo
	73697	5304202	5002	2	Morsetto di derivazione doppio

Pressacavi - PG - IP68

	Articolo	Prog.	Codice	Filetto	Colore	Conf.
	V-TEC	74240	2024705	Pg 7	Grigio chiaro	50
		74241	2024713	Pg 9		50
		74242	2024721	Pg 11		50
		74239	2024748	Pg 13.5		50
		74243	2024756	Pg 16		25
		74244	2024764	Pg 21		25
		74245	2024772	Pg 29		20
		74246	2024780	Pg 36		10

Pressacavi - metrico - IP68



	Articolo	Prog.	Codice	Filetto	Colore	Conf.
	VTEC	74247	2022862	M12X1.5	Grigio chiaro	50
		74248	2022864	M16X1.5		50
		74249	2022866	M20X1.5		50
		74250	2022868	M25X1.5		25
		74251	2022870	M32X1.5		20
		74252	2022872	M40X1.5		10

Controdado - PG - in poliammide



	Articolo	Prog.	Codice	Filetto	Colore	Conf.
	116 VDE	74253	2048078	Pg 7	Grigio chiaro	100
		74254	2048094	Pg 9		
		74255	2048116	Pg 11		
		74256	2048132	Pg 13.5		
		74257	2048167	Pg 16		
		74258	2048221	Pg 21		
		74259	2048299	Pg 29		50
		74260	2048361	Pg 36		25

Scaricatori di tensione

Blocco potenziale e di connessione di messa a terra

	Prog.	Codice						Descrizione
	72652	5094650	1+NPE	20KA	centralino appartamento MONOFASE	V20/C1+NPE	SURGECONTROLLER	Limitatore di sovratensione
	72654	5094457	1+NPE	30KA	Per protezione apparati elettronici monofase	V25B+C/1+NPE	COMBICONTROLLER V25	Limitatore di corrente da fulmine e di sovratensione trifase
	72655	5094463	3+NPE		Per protezione apparati elettronici trifase	V25B+C/3		
	72653	5094656	3+NPE	60KA	TRIFASE	V20/C3+NPE	SURGECONTROLLER	Limitatore di sovratensione

Scaricatori di tensione

	Prog.	Codice			Polarità	Potenza	
	72656	5096849	MCD50-B	Scaricatore di corrente da fulmine	L+N	50KA	Da abbinare sempre con il modulo MCD125-B
	72657	5096865	MCD125-B		N+PE	125KA	Da abbinare sempre con il modulo MCD50-B